

BT ELECTRONICS

≡ Our Standard Program ...

6, avenue des Andes - Mini parc Bât 4
 ZA de Courtaboeuf
 91940 LES ULIS - FRANCE
 Tél.: (33) 01 69 18 16 60 - Fax: (33) 01 60 92 07 91
 E-mail: bt.electronics@orange.fr - Site: www.bt-electronics.com

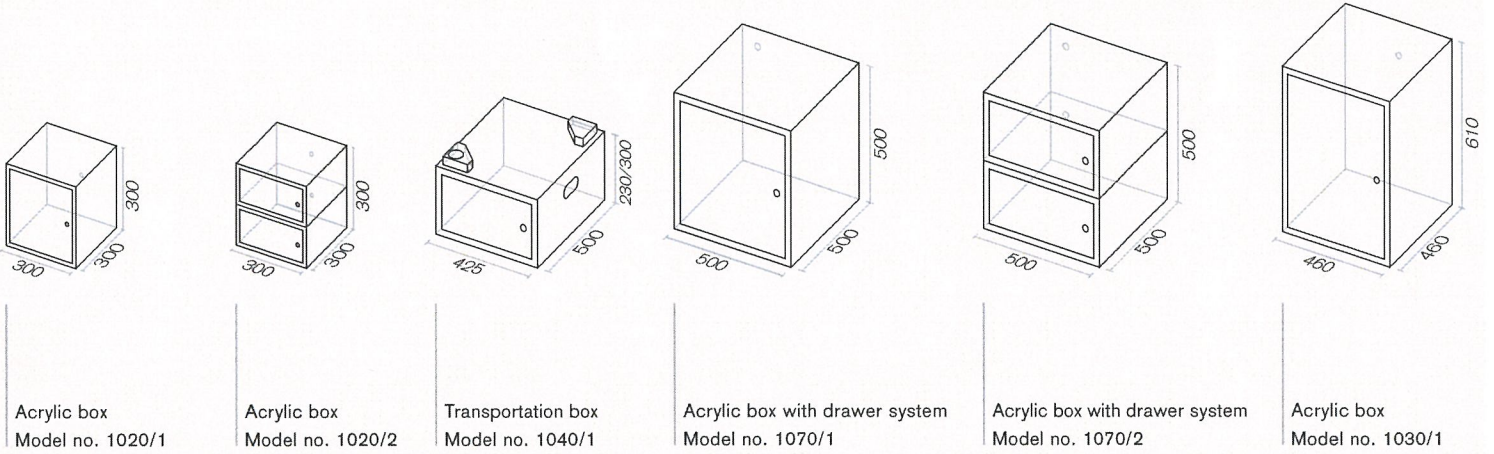

≡ ... and our customized versions

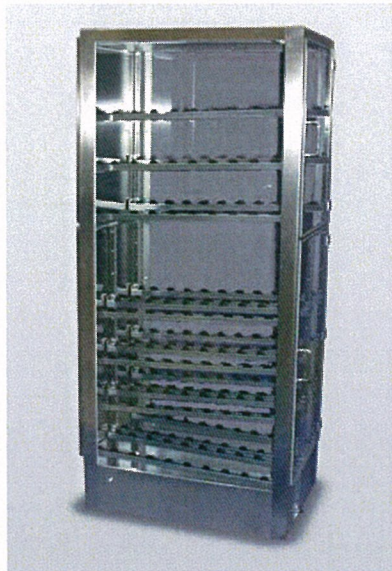

A23

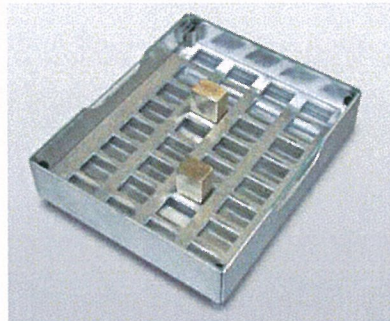

A24



A25

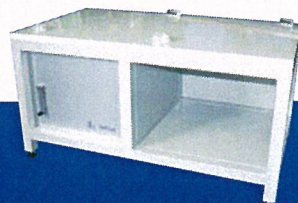

A26

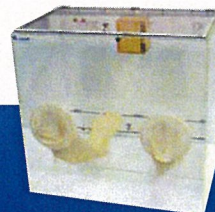

A27



A28

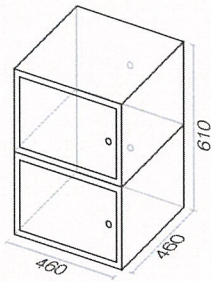

Acrylic box
Model no. 1030/2

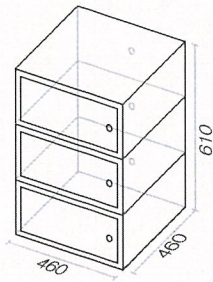

Acrylic box
Model no. 1030/3

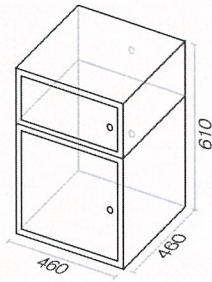

Acrylic box
Model no. 1030/4

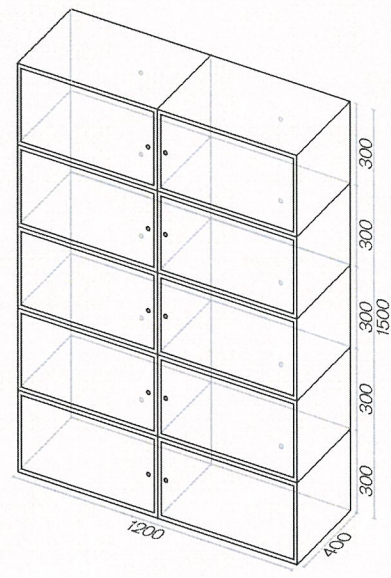

Acrylic cabinet
Two to ten doors
Model no. 1060/2-10

≡ Our Product and Service Spectrum – an Overview

As one of the leading clean room technology providers we develop and produce customer specific system solutions for a wide array of uses:

- ≡ Clean rooms
- ≡ Clean work places
- ≡ Storage systems
- ≡ Wet process technology
- ≡ Services

BT ELECTRONICS

6, avenue des Andes - Mini parc Bât 4
ZA de Courtaboeuf
91940 LES ULIS - FRANCE
Tél.: (33) 01 69 18 16 60 - Fax: (33) 01 60 92 07 91
E-mail: bt.electronics@orange.fr - Site: www.bt-electronics.com